

0115 921 0430

CAME UNITED KINGDOM LTD
ORCHARD PARK INDUSTRIAL ESTATE
TOWN STREET, SANDIACRE,
NOTTINGHAM, NG10 5BP

TEL: 0115 921 0430
FAX: 0115 921 0431

INTERNET - www.cameuk.com
E-MAIL - enquiries@cameuk.com

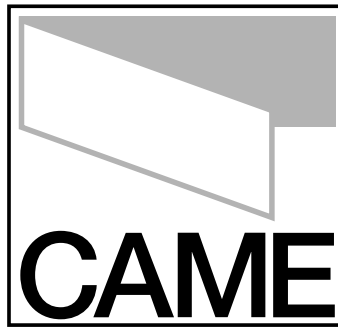

**TECHNICAL
HELPLINE
0115 921 0430**

FROG KIT

*Installation Instructions
for a "Single" gate...*

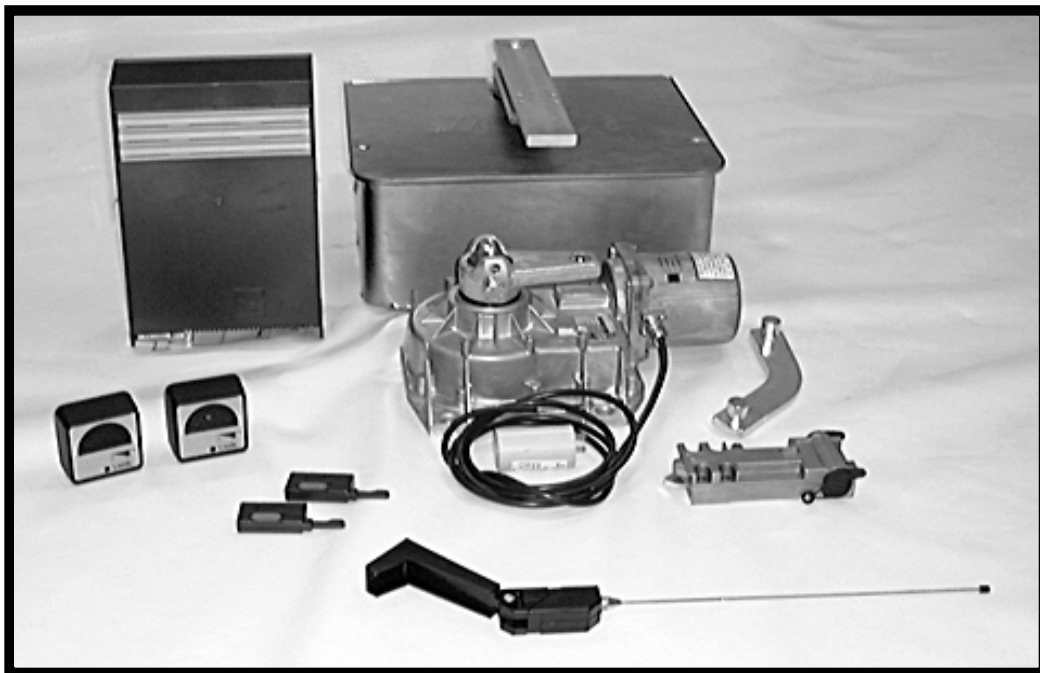

THE FROG-S KIT CONSISTS OF:

- 1 X UNDERGROUND FOUNDATION CASINGS***
- 1 X UNDERGROUND GATE MOTORS***
- 1 X CONTROL PANEL***
- 1 X RADIO FREQUENCY CARD***
- 1 X TUNED ANTENNA***
- 2 X REMOTE CONTROL TRANSMITTERS***
- 1 X PAIR SAFETY BEAMS***

INTRODUCTION

THESE INSTRUCTIONS WILL SHOW YOU HOW TO INSTALL A FROG UNDERGROUND GATE KIT TO A SINGLE GATE.

PLEASE READ THESE INSTRUCTIONS AND DIAGRAMS CAREFULLY BEFORE STARTING ANY WORK.

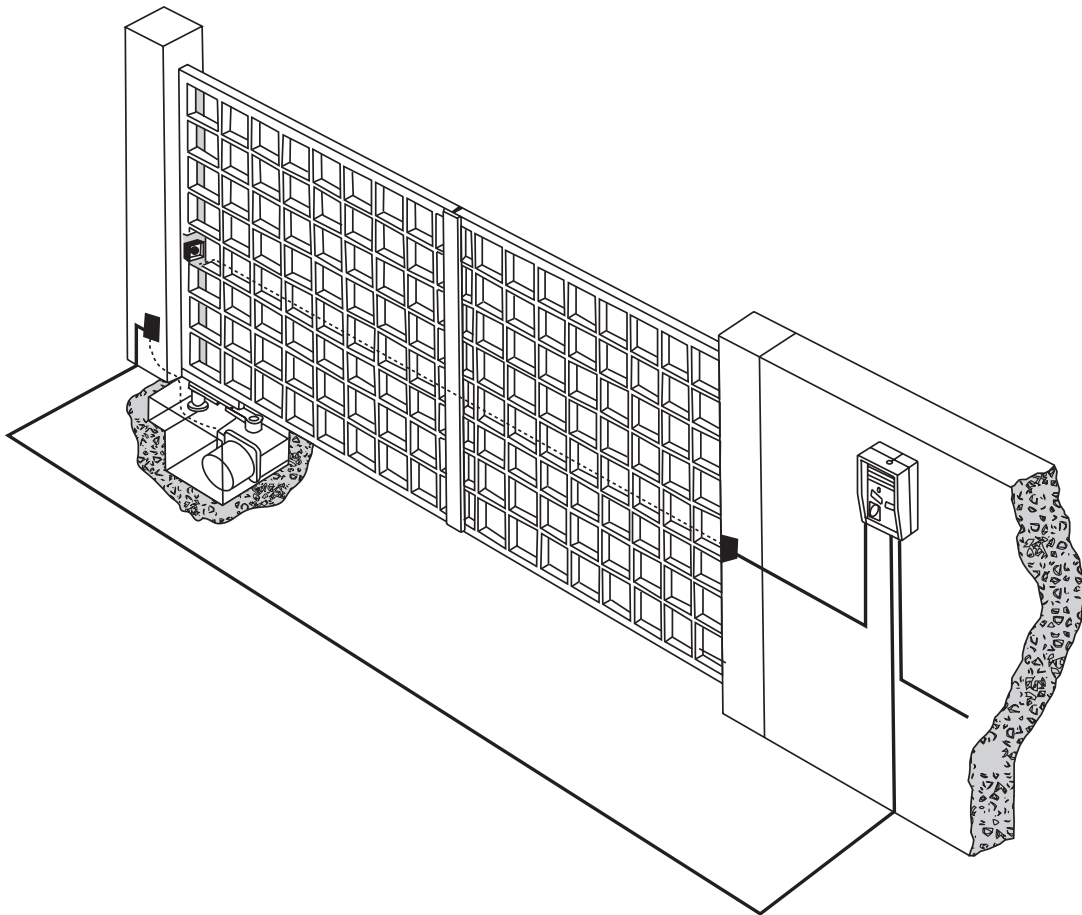

UNDER NO CIRCUMSTANCES SHOULD THIS EQUIPMENT BE OPERATED UNLESS FITTED TO A GATE.

FAILURE TO COMPLY WILL INVALIDATE THE GUARANTEE.

INSTALLATION INSTRUCTIONS

CONTENTS

1) Stage 1:- Civil & Mechanical Section		Page
1.1	INSTALLATION OF THE FOUNDATION	3
1.2	BASIC CABLE LAYOUT	4
1.3	LOW VOLTAGE CABLE LAYOUT	4
1.4	INSTALLING THE MOTOR	5
1.5	HANGING THE GATE	5
1.6	FITTING THE GATE LOCK	6
2) Stage 2:- Wiring & Electrical		
2.1	FITTING THE CONTROL PANEL IN THE CASING	8
2.2	WIRING THE MOTOR	9
2.3	WIRING IN THE SAFETY PHOTOCELLS	10
2.4	INSERTING THE RADIO FREQUENCY CARD	10
2.5	WIRING IN THE TUNED ANTENNA	11
2.6	CODING THE REMOTE CONTROLS	11
2.7	POWERING UP THE CONTROL PANEL	11
3) Stage 3:- Commissioning the Control Panel		
3.1	INITIAL WIRING & CONTROL PANEL SETUP	13
3.2	OPENING & CLOSING THE GATE	14
3.3	CONTROL PANEL ADJUSTMENTS	15
3.4	AUTOMATIC CLOSE & SAFETY PHOTOCELLS	16
3.5	PROGRAMMING THE REMOTE CONTROLS TO THE CONTROL PANEL	17
4) Troubleshooting Guide		19
5) Technical Information		20
5.1	TECHNICAL SPECIFICATIONS	21
5.2	CASING DIMENSIONS	21
5.3	OPERATING LIMITS	21
5.4	MOTOR TORQUE SETTINGS	22
5.5	ZA5 CONTROL PANEL DESCRIPTION	23
5.6	ZA5 WIRING DIAGRAM	25
5.7	CONTROL PANEL ADJUSTMENTS	26
5.8	ELECTRICAL CONNECTIONS	27
5.9	DIPSWITCH FUNCTIONS	29
5.10	RE-HANDING THE MOTOR	30
6) Contact Information		

STAGE 1

CIVIL & MECHANICAL SECTION

1.1 - Installation of Foundation Casing

THE UNDERGROUND CASING SHOULD BE CONCRETED IN THE GROUND. THE CASING SHOULD HAVE ADEQUATE DRAINAGE TO A SUITABLE SOAK AWAY. WHEN INSTALLING THE FOUNDATION CASING AS A GUIDE ALLOW APPROXIMATELY 100mm AROUND THE CASING AND 100mm UNDERNEATH THE CASTING FOR CONCRETE.

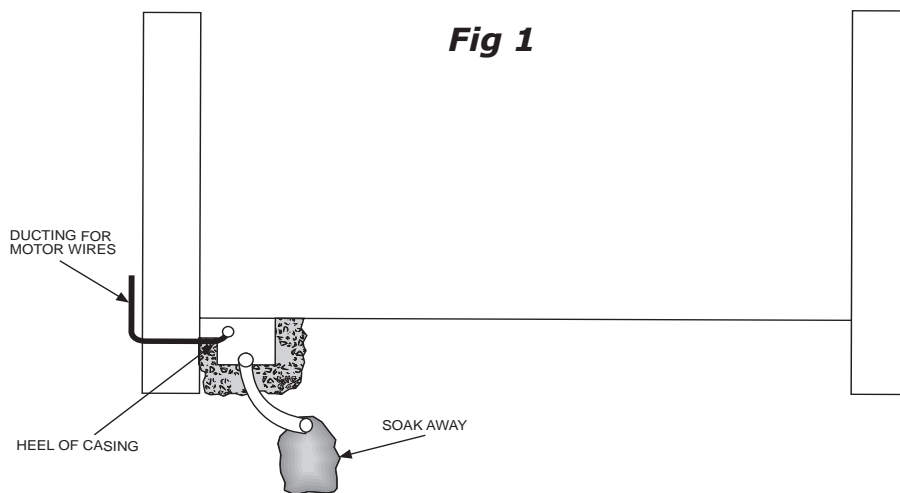

WHEN CONCRETING THE CASING IN PLACE, ENSURE THAT THE HEEL OF THE CASING IS PACKED WITH CONCRETE AS THIS WHERE ALL OF THE WEIGHT OF THE GATE WILL SIT. ALLOW AT LEAST TWO DAYS FOR THE CONCRETE TO GO OFF.

WHEN SETTING THE CASING IN PLACE ENSURE THAT THE TOP HINGE PIN IS PLUMB IN LINE WITH THE HINGE PIVOT IN THE CASING. THE CENTRE OF PIVOT IS 65mm STANDOFF FROM THE BACK OF THE CASING. THE CASING SHOULD BE SET PERFECTLY SQUARE AND LEVEL AND PROTRUDING APPROXIMATELY 3mm FROM GROUND LEVEL.

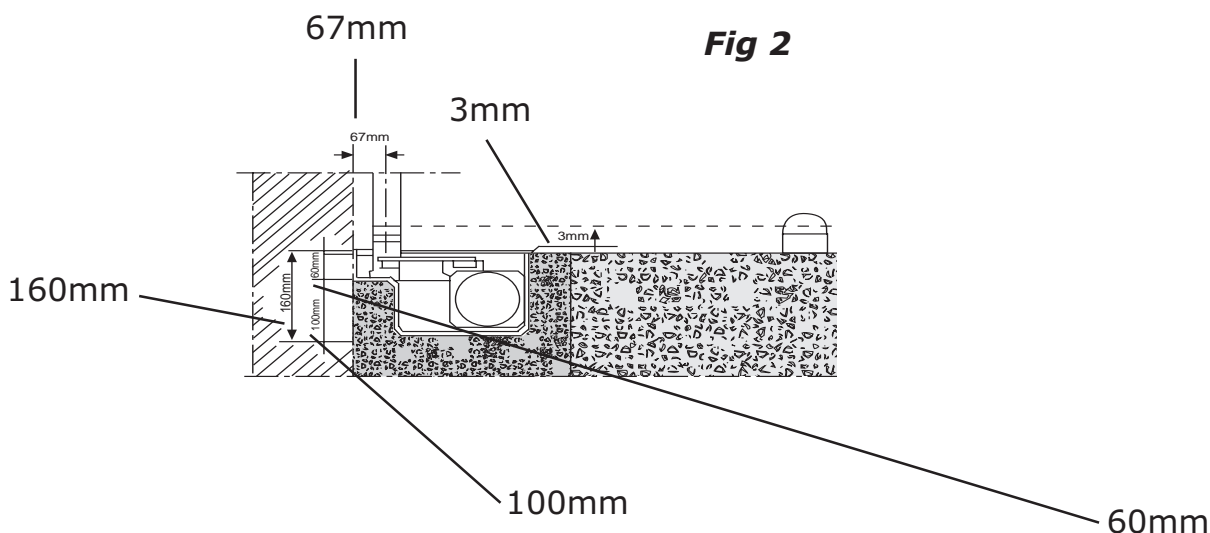

1.2 - Basic Cable Layout

THIS DIAGRAM DETAILS THE BASIC CABLE LAYOUT FOR A SINGLE MOTOR.

THE POWER SUPPLY TO THE CONTROL PANEL SHOULD BE LIVE AND PROTECTED IN ACCORDANCE WITH THE 16TH EDITION ELECTRICAL REGULATIONS. THE SUPPLY SHOULD BE RATED AT A MINIMUM OF 6 AMPS. WHEN INSTALLING WIRES OUTDOORS THE CABLE APPROACH TO ALL DEVICES MUST BE FROM BELOW TO CREATE A "DRIP-LOOP" AND THEREBY AVOID UNNECESSARY WATER INGRESS.

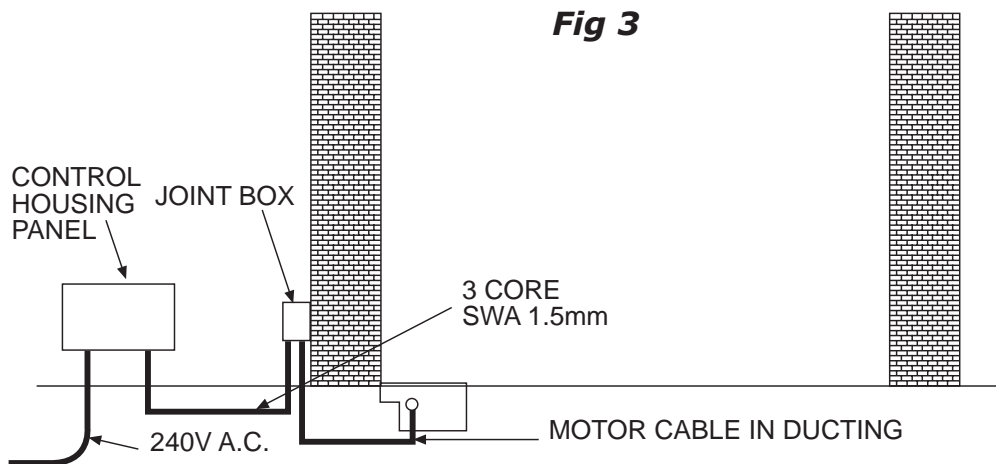

1.3 - Low Voltage Cable Layout

WHEN INSTALLING LOW VOLTAGE CABLE AROUND THE GATEWAY IT IS ADVISED TO PUT ALL LOW VOLTAGE CABLE IN EITHER DUCTING OR ALKATHENE PIPING. ALL CABLE JOINTING SHOULD BE CARRIED OUT ABOVE GROUND.

ALL CAME ACCESSORIES CAN BE WIRED IN 0.2mm STRANDED LOW VOLTAGE CABLE (BURGLAR ALARM TYPE). TUNED ANTENNA SHOULD BE WIRED WITH COAXIAL CABLE.

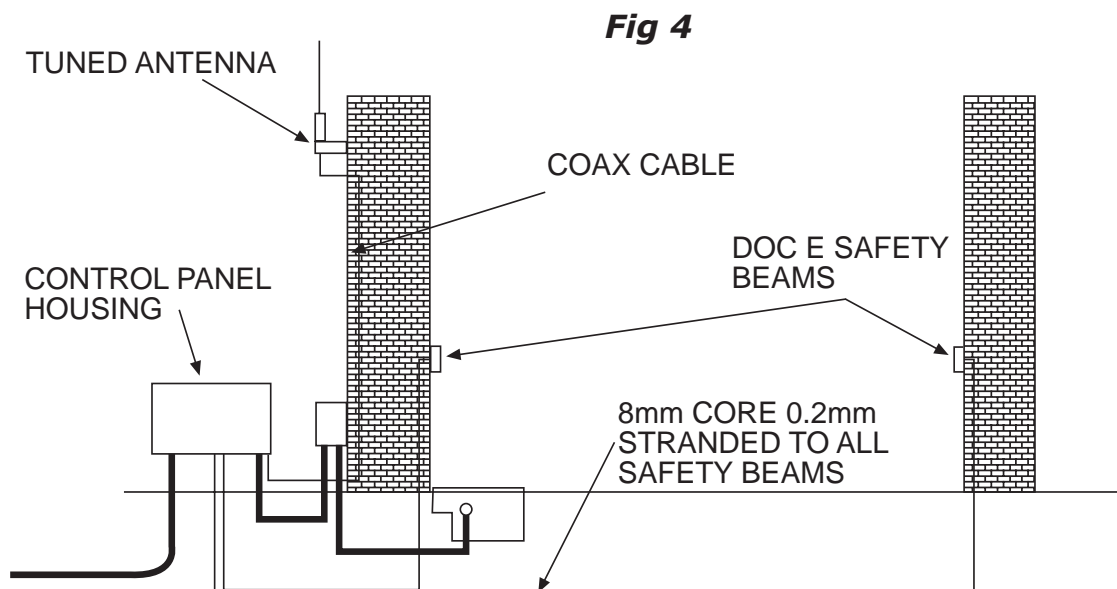

1.4 - Installing the Motors

INSERT THE MOTORS ONTO THE STUDS IN THE CASING. IF THE GATES ARE HUNG BETWEEN THE POSTS AND THE GATES OPEN INWARDS THE MOTORS NEED TO BE POINTING INTO THE PROPERTY.

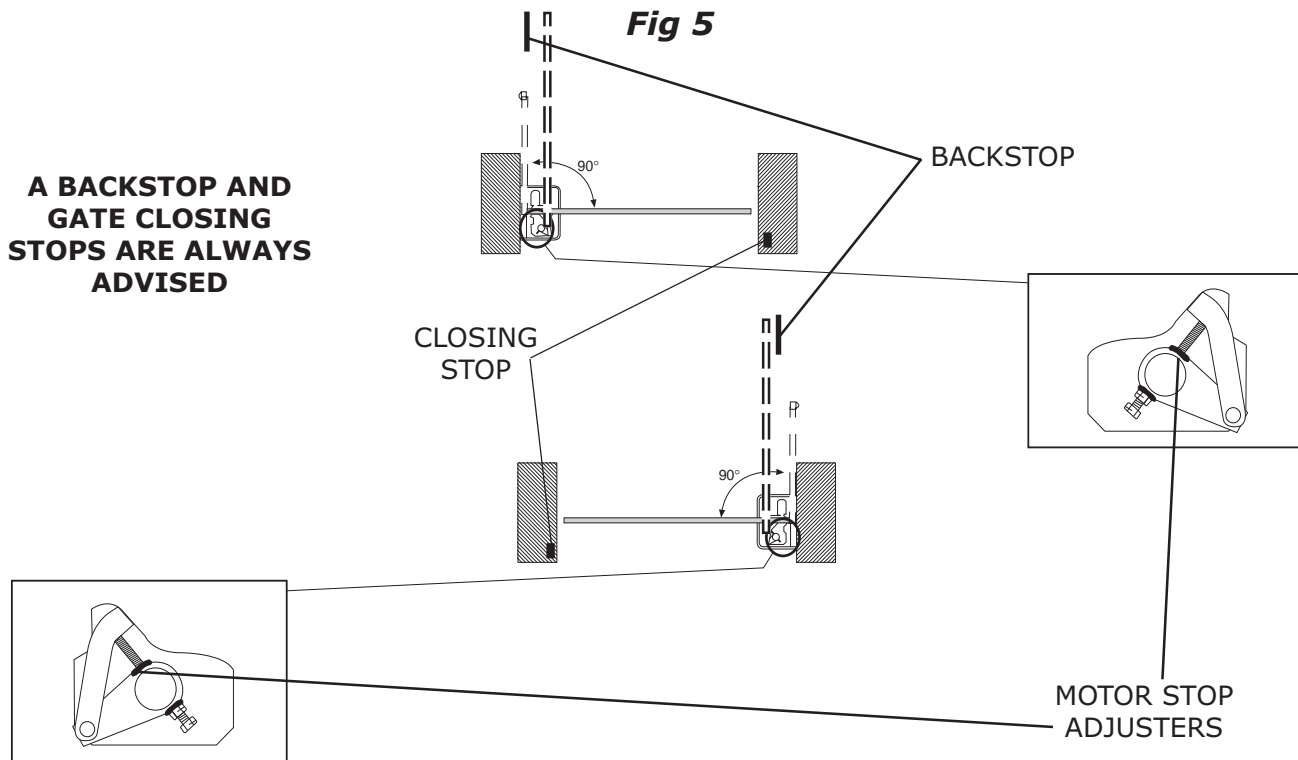

IF THE GATES ARE HUNG ON THE BACK OF THE POSTS THE MOTORS NEED TO BE POINTING TOWARDS THE OTHER POST.

1.5 - Hanging the Gate

BEFORE ATTACHING THE GATE ENSURE THAT THE GATE PIVOT POINT IS ADEQUATELY GREASED.

WHEN HANGING THE GATE ENSURE THAT IT IS SQUARE AND LEVEL BEFORE WELDING THE GATE TO THE FROG SHOE. WHEN WELDING THE GATE TO THE FROG SHOE **DO NOT** WELD OVER THE THREADED HOLES IN THE SHOE.

WHEN HANGING A WOODEN GATE IT IS NECESSARY TO CREATE A U-SHAPED CARRYING SHOE IN MILD STEEL WHICH CAN BE WELDED TO THE TOP SURFACE OF THE FROG SHOE. THEN THE WOODEN GATE CAN BE BOLTED INTO POSITION WITH THE U-SHAPED CARRYING SHOE CLAMPING TO THE BOTTOM OF THE GATE.

1.6 - Fitting the Gate Lock

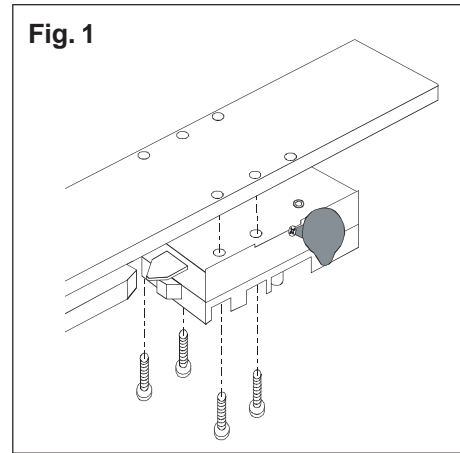
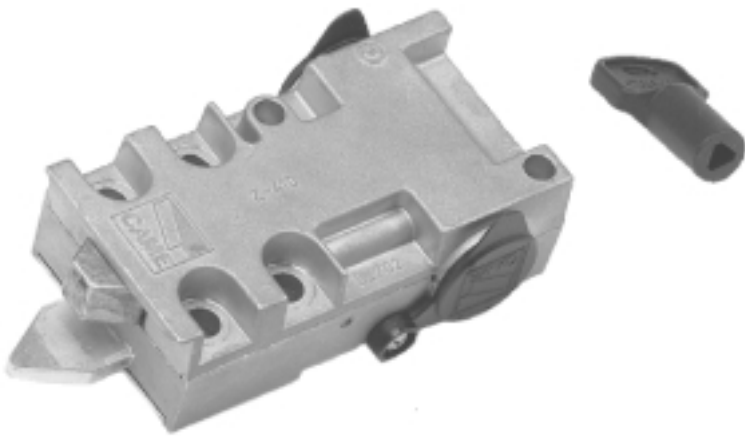

Secure the unlocking device to the FROG shoe with the 4 allen bolts provided.

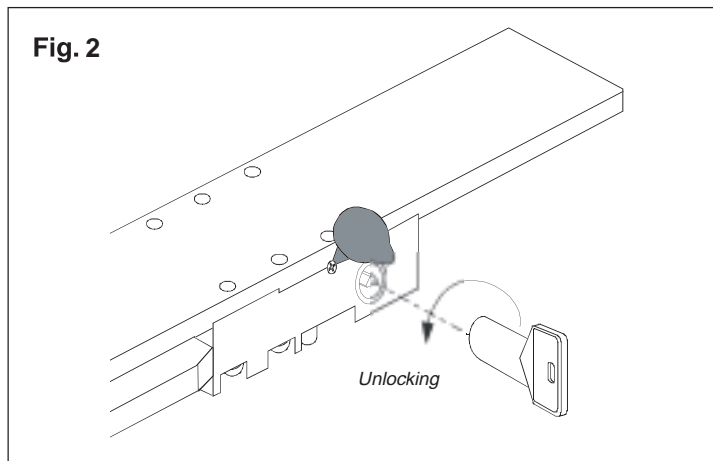

To release the gate, raise the protective cap, insert the three sided key and turn it to activate the mechanism. Simultaneously push and/or pull the gate. Remove the key and replace the protective cap.

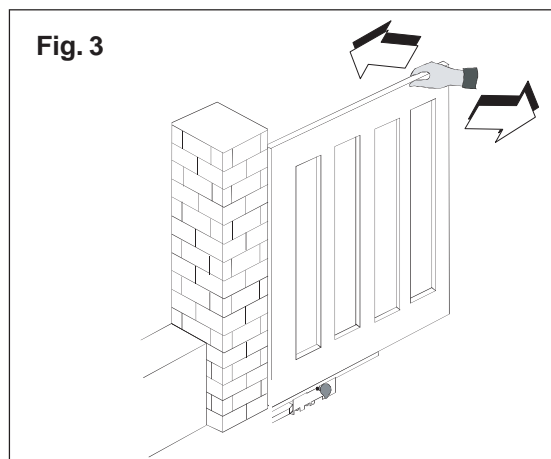

To re-engage the gate, reposition the gate and the mechanism will automatically engage it.

END OF INSTALLATION STAGE 1

**BEFORE STARTING STAGE 2 - Wiring & Electrical
PLEASE CHECK THAT YOU HAVE CORRECTLY:**

	Ref	Page
1. INSTALLED THE FOUNDATION CASING	1.1	3
2. PREPARED THE CABLING CORRECTLY	1.2	4
	1.3	4
3. INSTALLED THE MOTOR CORRECTLY	1.4	5
4. HUNG THE GATE CORRECTLY	1.5	5
5. CHECKED THE MANUAL RELEASE SYSTEM	1.6	6

**NOW STAGE 1 IS FULLY COMPLETED YOU ARE READY TO
BEGIN STAGE 2 OF YOUR FROG AUTOMATION KIT
INSTALLATION**

STAGE 2 - WIRING & ELECTRICAL

2.1 - Fitting the Control Panel in the Casing

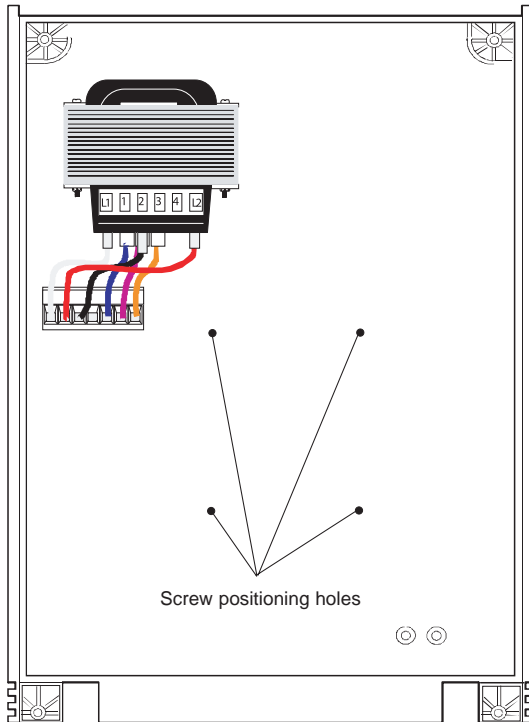

Securely fasten the control panel PCB to the casing with the screws supplied.

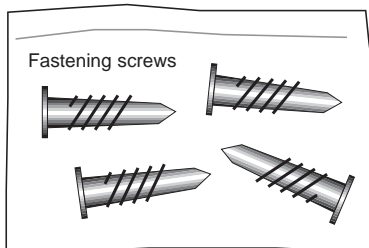

Green connector point

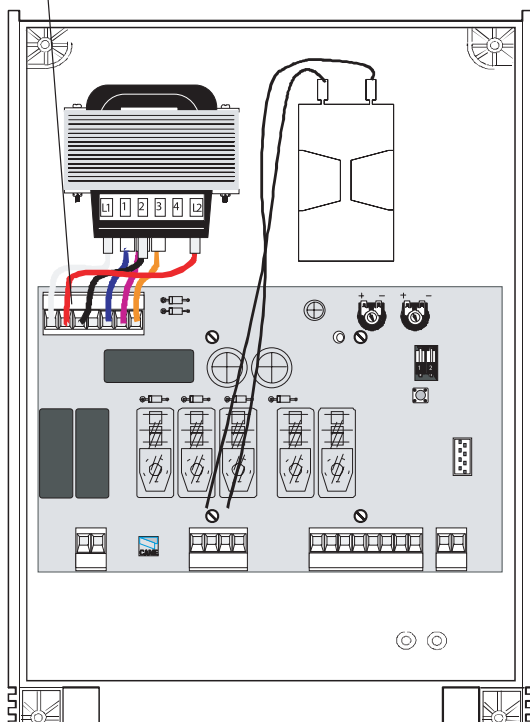
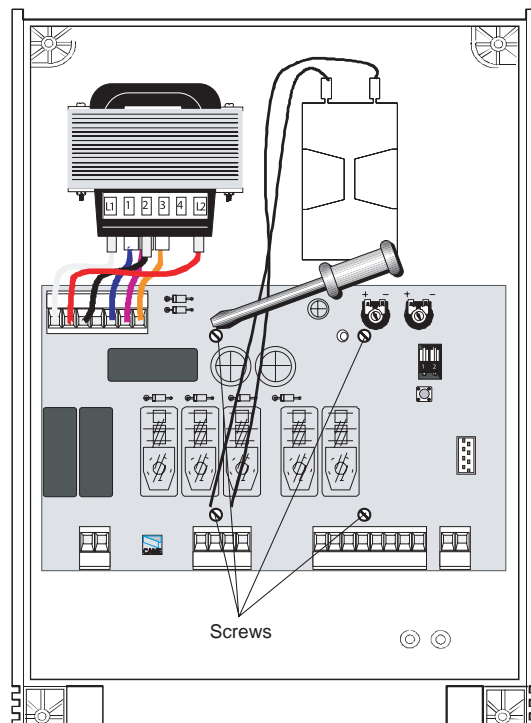

Plug the green connector from the transformer to the PCB ensuring that it connects the correct way.

NB FROG Series Motors: connect the black wires coming out of the board to one capacitor.

2.2 - Wiring the Motor

THE FROG MOTOR ALWAYS COMES PREWIRED AND THE CONNECTIONS TO THE MOTOR SHOULD BE MADE IN THE JUNCTION BOXES AT THE BASE OF THE GATE POST (I.E OUT OF THE GROUND OR FOUNDATION CASING) AS SHOWN IN FIG 3.

UNDER NO CIRCUMSTANCES MUST THE MOTOR BE DISCONNECTED FROM THE GEARBOX AS THIS WILL INVALIDATE THE WARRANTY.

WHEN CONNECTING THE MOTOR TO THE CONTROL PANEL THE BLUE WIRE ON THE MOTOR IS THE COMMON WIRE AND IS ALWAYS TO THE "W" ON THE TERMINAL STRIP IN THE CONTROL PANEL. THE BROWN AND BLACK WIRES ARE THE MOTOR DIRECTIONS AND ARE CONNECTED TO "X+Y" FOR MOTOR 2. MOTOR 2 IS ALWAYS USED FOR SINGLE GATE INSTALLATIONS.

ENSURE THAT THE MOTOR IS ADEQUATELY EARTHED.

Fig 7

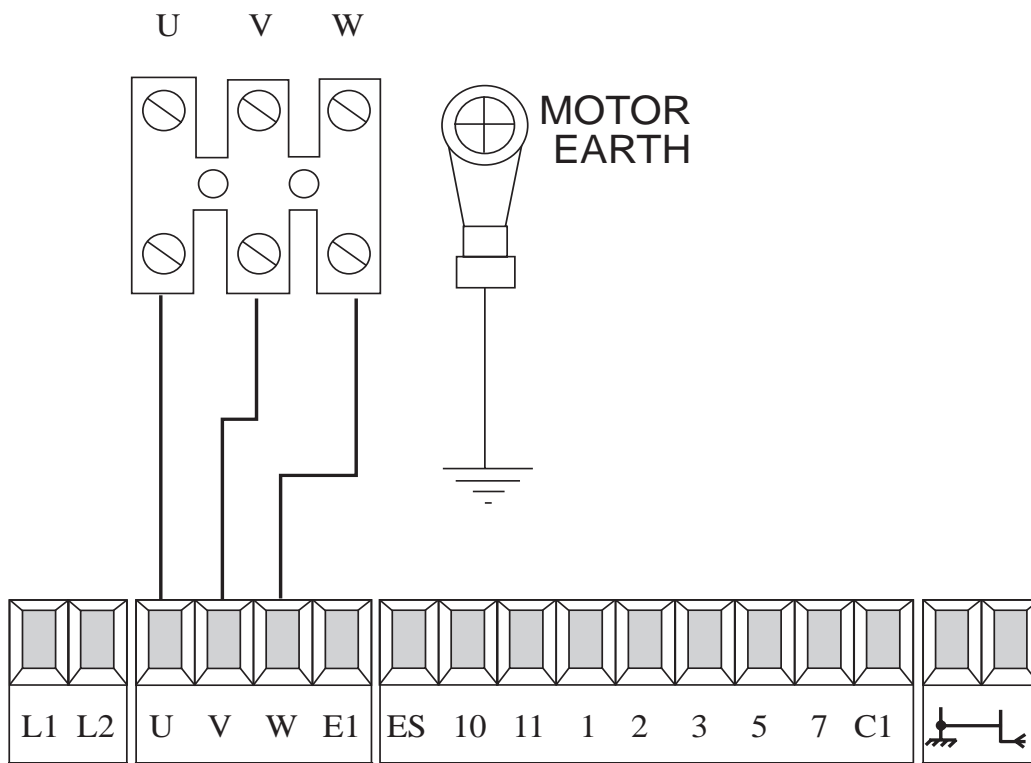

2.3 - Wiring in the Safety Photocells

SAFETY BEAMS SHOULD BE FITTED APPROXIMATELY
15 INCHES FROM GROUND LEVEL

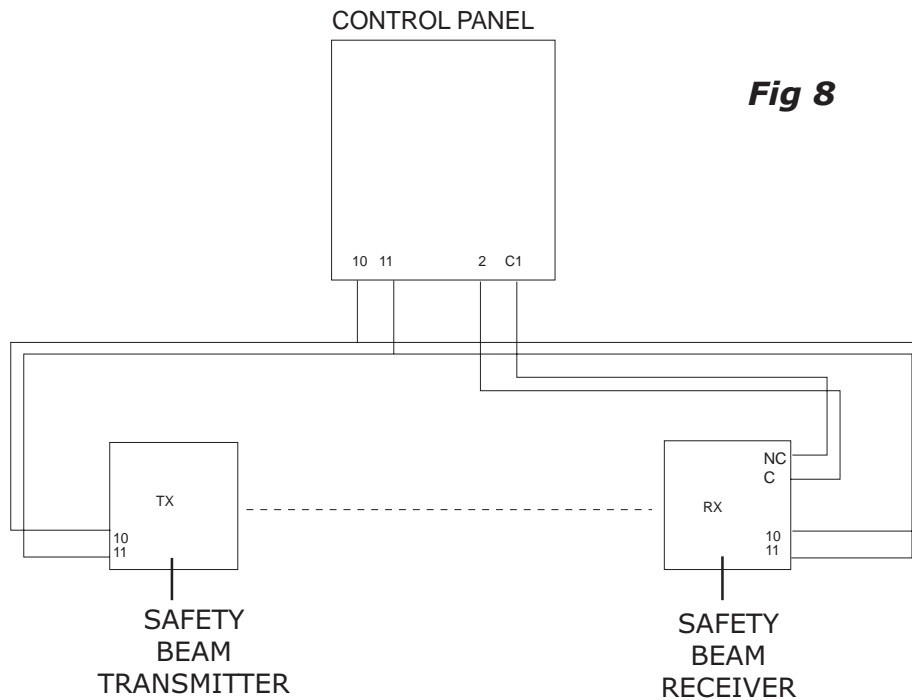

IF FITTING A SECOND ARC LINE OF SAFETY BEAMS THEN C & NC MUST BE WIRED IN "SERIES"

2.4 - Inserting the Radio Frequency Card

Fig 9

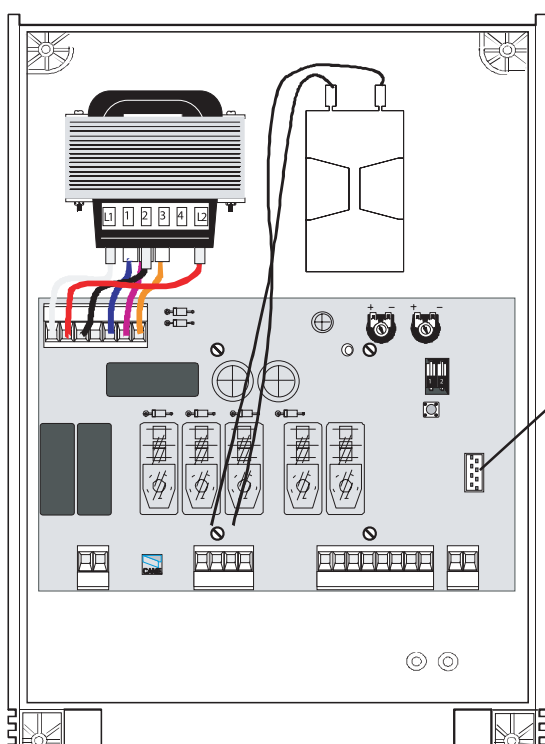

INSERT THE RADIO FREQUENCY
CARD INTO THE SMALL SOCKET
ON THE CONTROL PANEL
(ENSURE THAT THE POWER IS
TURNED **OFF** TO THE CONTROL
PANEL BEFORE INSERTING THE
FREQUENCY CARD)

ANTENNA
WIRING
POINT

2.5 - Wiring in the Tuned Antenna

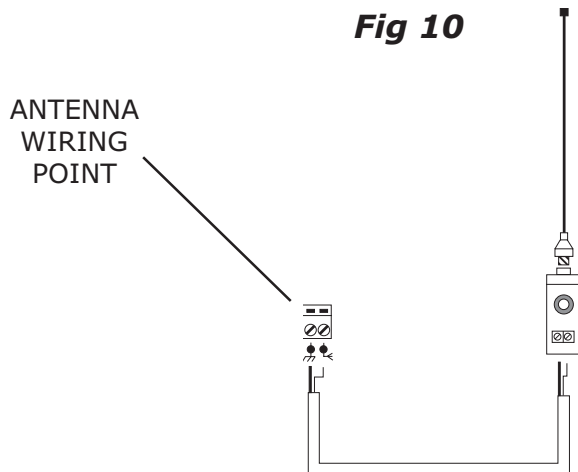

2.6 - Coding the Remote Controls

1. REMOVE THE BATTERY COVER & CASING OF THE REMOTE CONTROL HANDSET TO REVEAL THE DIAGRAM BELOW

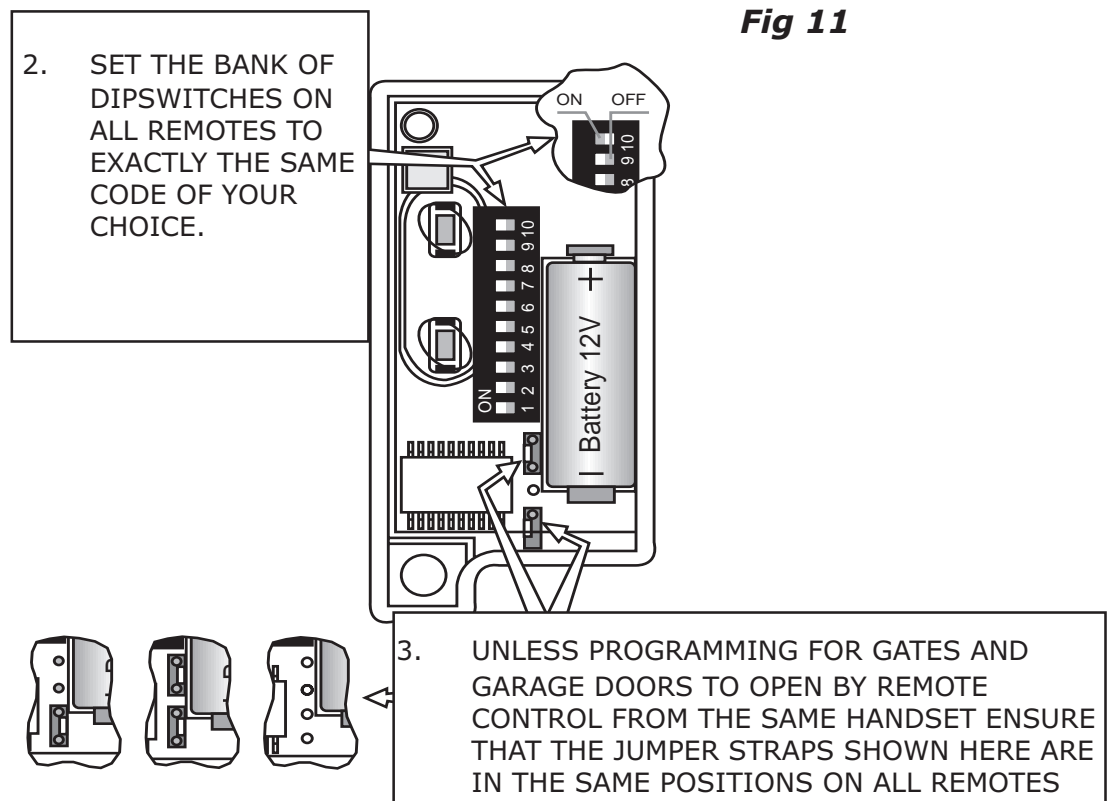

2.7 - Powering up the Control Panel

CONNECT PROTECTED MAINS POWER TO TERMINALS L1 + L2 IN THE CONTROL PANEL (**L2 BEING LIVE!**). ENSURE THAT THE CONTROL PANEL IS ADEQUATELY EARTHED.

END OF INSTALLATION STAGE 2

BEFORE STARTING STAGE 3 - Commissioning the Control Panel

PLEASE CHECK THAT YOU HAVE CORRECTLY:

	Ref	Page
1. FITTING THE CONTROL PANEL IN THE CASING	2.1	8
2. WIRED THE MOTOR AS SHOWN (Fig 7)	2.2	9₁₂
3. WIRED IN THE SAFETY PHOTOCELLS AS SHOWN (Fig 8)	2.3	10
4. INSERTED THE RADIO FREQUENCY CARD AS SHOWN (Fig 9)	2.4	10
5. WIRED IN THE TUNED ANTENNA CODED AS SHOWN (Fig 10)	2.5	11
6. PROGRAMMED THE REMOTE CONTROLS AS SHOWN (Fig 11)	2.6	11
7. POWERED UP THE CONTROL PANEL	2.7	11

**NOW STAGE 2 IS FULLY COMPLETED YOU ARE READY TO
BEGIN STAGE 3 OF YOUR FROG AUTOMATION KIT
INSTALLATION**

STAGE 3

COMMISSIONING THE CONTROL PANEL

3.1 - Initial Wiring & Control Panel Setup

Fig 12

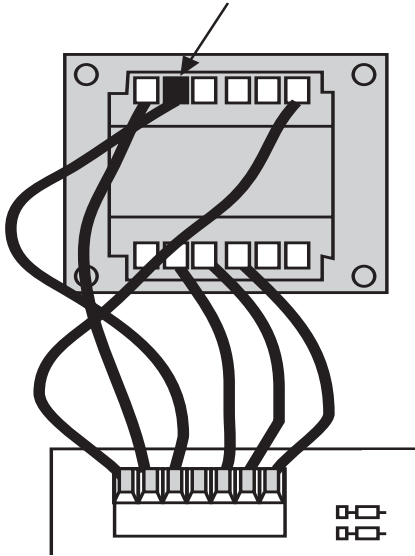

1. CONNECT POWER TERMINALS L1 - L2 AND A SUITABLE EARTH (**L2 BEING LIVE!**)
2. SELECT THE MOTOR POWER SETTING ON THE TRANSFORMER TO LEVEL 1 FOR COMMISSIONING

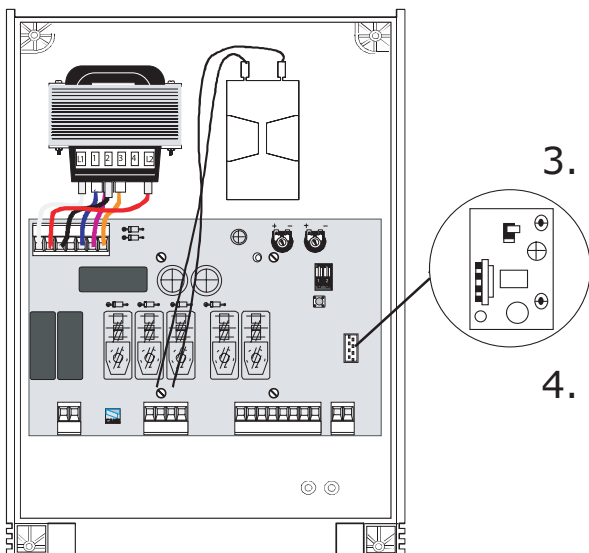

3. INSERT THE 'START-UP' CAPACITOR INTO THE CONTROL PANEL. THE TWO BLACK WIRES SHOULD BE CONNECTED TO THE CAPACITOR.
4. ENSURE THAT THE MOTORS ARE ADEQUATELY **EARTHED**

Fig 13

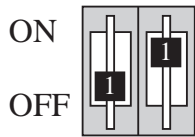

Fig 14

5. SELECT DIPSWITCHES 1 & 2 OFF FOR COMMISSIONING

6. ENSURE HARD WIRE LINK IS FITTED BETWEEN TERMINALS 1 & 2 AND 2 & C1

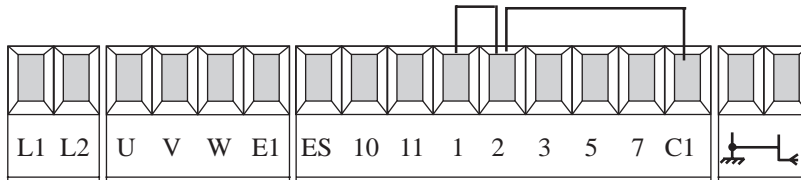

Fig 15

3.2 - Opening & Closing the Gate

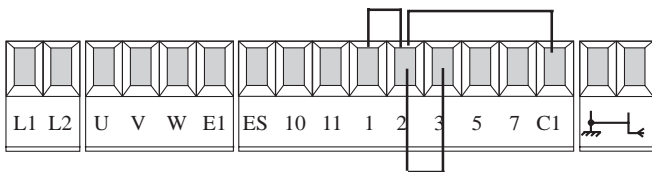

Fig 16

1. MOMENTARILY PULSE TERMINALS 2 & 3 WITH A PIECE OF WIRE TRAILING FROM TERMINAL 2 AND MOMENTARILY TOUCHING TERMINAL 3.

THE GATE SHOULD START TO OPEN. IF THE MOTOR STARTS TO CLOSE TURN THE POWER OFF TO THE CONTROL PANEL AND CHANGE AROUND X-Y (MOTOR 2) TO CHANGE THE MOTOR DIRECTION.

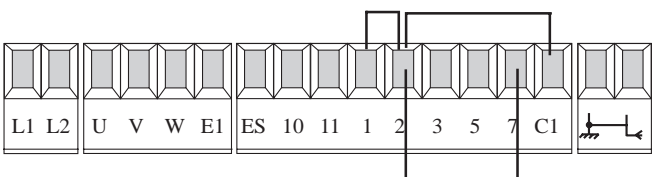

Fig 17

2. ONCE YOU HAVE PROVED THE MOTOR DIRECTION USE TERMINALS 2 & 7 TO OPEN AND CLOSE THE GATES WITH A TRAILING WIRE ONCE AGAIN INTO TERMINAL 2, MOMENTARILY TOUCHING TERMINAL 7.

3.3 - Control Panel Adjustments

1. TO SET THE TOTAL RUNNING TIME OF THE MOTORS, ADJUST POTENIOMETER TL TO ALLOW THE MOTORS TO RUN FOR A FURTHER 5-7 SECONDS AFTER THE MOVEMENT CYCLE HAS BEEN COMPLETED (I.E FULLY OPEN OR FULLY CLOSED)

Fig 19

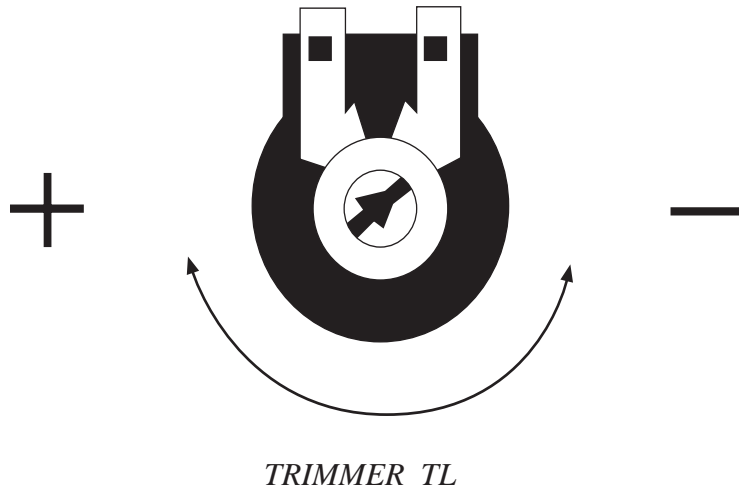

2. CHECK THE SENSITIVITY OF THE GATE BY TRYING TO PHYSICALLY STOP THE GATE AND ADJUST THE POWER SETTINGS ON THE TRANSFORMER ACCORDINGLY. IF MORE POWER IS NEEDED FOR A HEAVIER GATE THEN SWITCH OFF POWER AND MOVE TRANSFORMER WIRE UP TO SETTING 2. FOR RECHECKING SENSITIVITY, REPEAT PROCESS UP TO 3 OR 4 IF EVEN MORE POWER IS NEEDED.

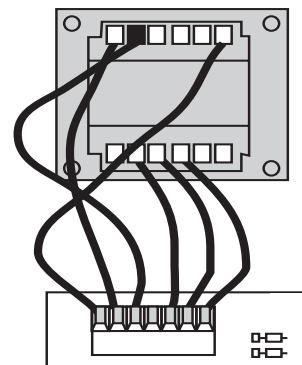
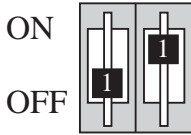

Fig 20

3.4 - Automatic Close & Activating Safety Photocells

Fig 21



1. TO SELECT AUTOMATIC CLOSING,
SELECT DIPSWITCH 2 **ON**.

SET THE AUTOMATIC CLOSING TIME BY ADJUSTING POTENTIOMETER TCA

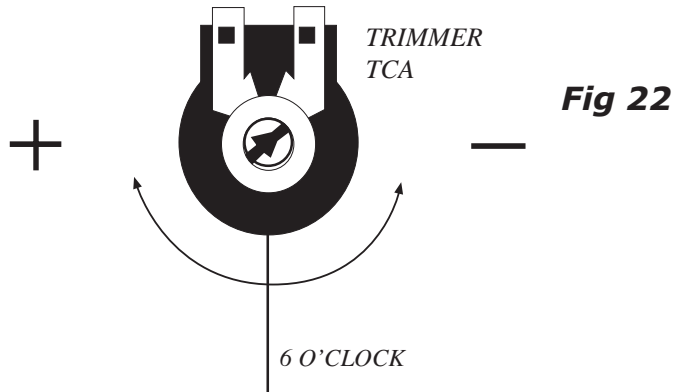

FULLY ANTI-CLOCKWISE WILL APPROX. AUTOMATICALLY CLOSE THE GATE AFTER 10 SECONDS AND FULLY CLOCKWISE WILL APPROX. CLOSE THE GATE AFTER 80 SECONDS. A SENSIBLE SETTING IS ABOUT HALFWAY (I.E 6 O'CLOCK POSITION) WHICH WILL AUTOMATICALLY CLOSE THE GATES AFTER APPROX. 30 SECONDS.

2. FOR RE-OPENING DURING CLOSING.
REMOVE HARD WIRE LINK BETWEEN 2 & C1 AND INSERT SAFETY BEAM WIRES AS SHOWN.

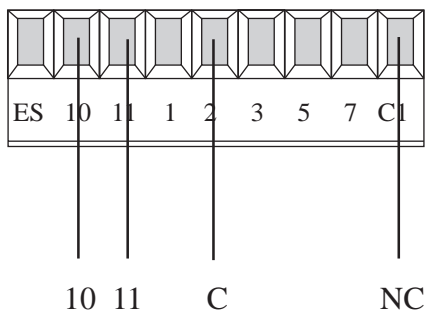

Fig 23

3.5 - Programming the Remote Controls to the Control Panel

To use the remote control system, proceed as follows:

- A) Turn power OFF and insert AF radio frequency board then turn power back on
- B) Code the transmitter. See the relevant instruction sheet (See Fig 11)
- C) To store the code on the circuit board Proceed as follows:

Press and hold down the YellowCH1 button on the radio receiver card (the signal LED will start to flash)

At the same time transmit on the top button of your remote control; keep both the top button and the yellow receiver button pressed until the LED stops flashing and remains on constant to indicate that the code has been successfully stored.

N.B. If you wish to change the code on your transmitter in the future, simply repeat the procedure above with all the remotes on the installation.

WARNING: Disconnect the power supply from the control board before inserting OR removing the AF radio-frequency card from the socket.

END OF INSTALLATION STAGE 3

PLEASE CHECK THAT YOU HAVE CORRECTLY:

	Ref	Page
1. SET POWER SETTING, INSERTED MOTOR CAPACITORS, SET DIPSWITCHES FOR COMMISSIONING, ENSURE WIRE LINK IS FITTED BETWEEN TERMINALS 1 & 2 AND 2 & C1	3.1	12
2. SET THE OPENING AND CLOSING TIMES FOR GATES	3.2	13
3. ADJUSTED THE CONTROL PANEL	3.3	14
4. IF REQUIRED, ACTIVATED AUTOMATIC CLOSING AND SAFETY PHOTOCELLS	3.4	15
5. PROGRAMMED THE REMOTE TO THE CONTROL PANEL	3.5	16

4. TROUBLESHOOTING GUIDE

A MULTIMETER WILL BE NEEDED

<i>PROBLEM</i>	<i>SOLUTION</i>
GATE WILL NOT RESPOND WHEN GIVEN A COMMAND	<ol style="list-style-type: none">1. CHECK POWER SUPPLY TO THE CONTROL PANEL.2. CHECK CONTROL PANEL FUSES.3. CHECK HARD WIRE LINK FITTED BETWEEN TERMINALS 1 & 2.4. CHECK THAT CAPACITORS ARE FITTED AND WIRED CORRECTLY.
GATE IS OPEN BUT WILL NOT CLOSE AND GREEN LED IS FLASHING	<ol style="list-style-type: none">1. CHECK SAFETY BEAMS ARE WIRED CORRECTLY. (IF MORE THAN ONE SET OF BEAMS ARE FITTED THEY MUST BE WIRED IN SERIES.)2. CHECK THAT THERE IS POWER GOING TO THE BEAMS, IF NOT RESTORE POWER.3. IF SAFETY BEAMS ARE NOT FITTED ENSURE THAT A HARD WIRE IS FITTED BETWEEN TERMINALS 2 & C1.4. REMOVE SAFETY BEAM WIRES 2 & C1 FROM CONTROL PANEL AND CHECK IF YOU HAVE A NORMALLY CLOSED CIRCUIT COMING FROM THE BEAMS.
WHEN COMMISSIONING GATE AUTOMATICALLY OPEN BUT DO NOT AUTOMATICALLY CLOSE	<ol style="list-style-type: none">1. MOTOR WIRES ARE WRONG WAY ROUND. CHECK AND PROVE MOTOR DIRECTION BY MOMENTORIALY PULSING TERMINALS 2 & 3. THE GATE SHOULD OPEN UP. TURN AUTOMATIC CLOSING <i>OFF</i> (DIP SWITCH 2) UNTIL MOTOR DIRECTION HAS BEEN PROVED.

CONTINUED ON NEXT PAGE

<i>PROBLEM</i>	<i>SOLUTION</i>
<p>GATE WILL NOT RESPOND TO REMOTE CONTROL COMMAND</p>	<ol style="list-style-type: none"> 1. AF FREQUENCY CARD NOT FITTED TO CONTROL PANEL. 2. REMOTE CONTROL HAS NOT BEEN PROGRAMMED INTO THE CONTROL PANEL. 3. REMOTE CONTROL HAS THE WRONG CODE SETTING. 4. "OPERATOR PRESENT" HAS NOT BEEN SELECTED TO DEACTIVATE RADIO REMOTE CONTROLS (DIPSWITCH 1). 5. WRONG FREQUENCY CARD FITTED FOR THE REMOTE CONTROL.

IF THE PROBLEM IS STILL APPARENT CONTACT THE CAME TECHNICAL HELPLINE:

0115 921 0430

THIS INSTALLATION WAS COMPLETED BY:

.....

NAME.....

ADDRESS.....

.....

.....

.....

TEL..... MOBILE.....

DATE OF INSTALLATION.....

5. TECHNICAL INFORMATION

5.1 - Technical Specification

GEARMOTOR	WEIGHT	POWER SUPPLY	CURRENT	POWER	DUTY CICLE	MAX. TORQUE	REDUCTION RATIO	TRAVEL TIME	CAPACITOR
FROG A	11 Kg	230V a.c	1,9 A	200 W	30%	* 320 Nm	1/1152	18 sec.	16 μ F
FROG AV	11 Kg	230V a.c	2,5 A	300 W	30%	* 240 Nm	1/1152	9 sec.	20 μ F

* Can be adjusted using CAME control panels

5.2 - Casing Dimensions

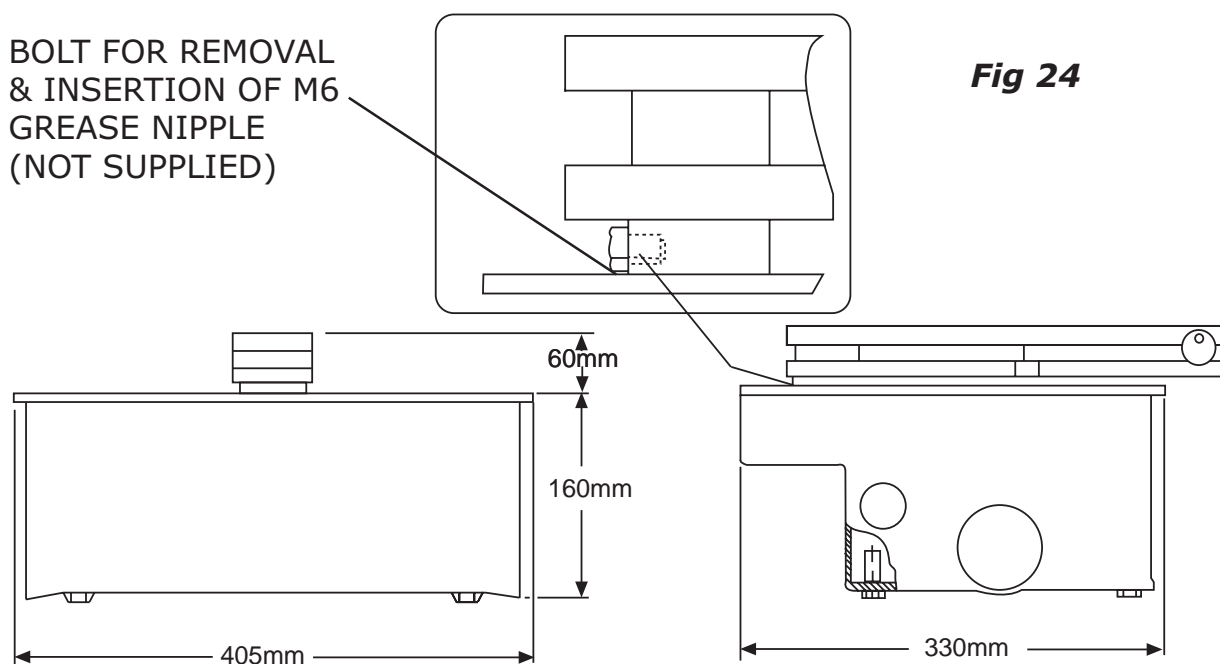

5.3 - Operating Limits

WIDTH OF GATE	WEIGHT OF GATE
2.00 MTS	800 Kg
2.50 MTS	600 Kg
*3.50 MTS	400 Kg

* AN ELECTRIC LOCK IS SUGGESTED WHEN THE GATE WING IS WIDER THAN 3.5M

5.4 - Motor Torque Settings

SEE ALSO PAGE 14

To vary the motor torque, move the indicated spade connector to one of the four position : 1=min, 4=max.

N.B. It is always best to start from position one and increase the torque setting as required.

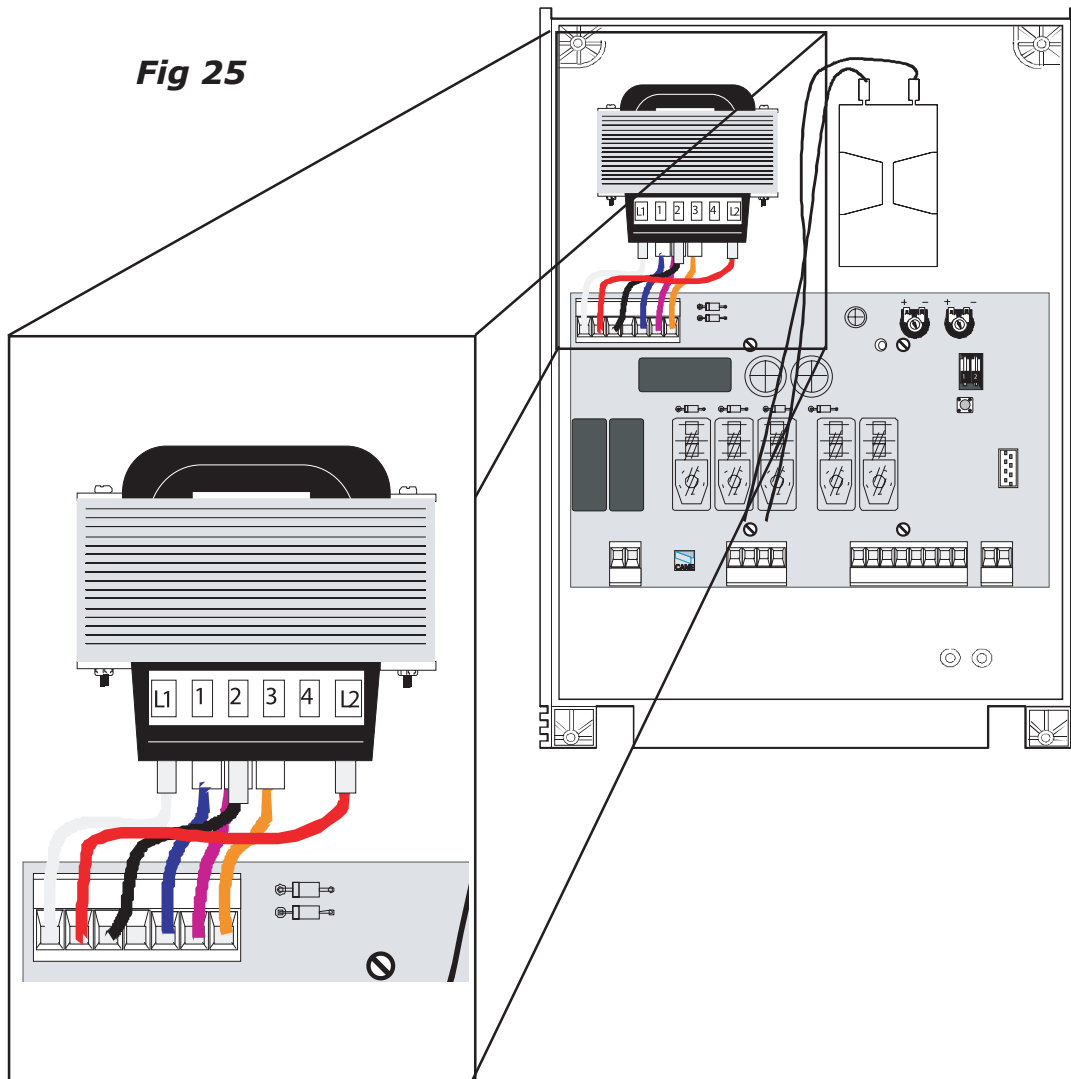

5.5 - ZA5 Control Panel Description

Description of Control Panel:

The ZA5 control board is suitable for controlling one automation of ATI, FERNI and FROG series 230V swing gates with up to 600W power and 50-60Hz frequency. Wholly designed and built by CAME S.p.A. it meets UNI8612 regulations in force. The board is inserted and fixed to the ABS case (S4339 or S4340), which has an IP54 protection level, with air recycling inlet and transformer. The board requires 230V AC at terminal blocks L1-L2 and the inlet is protected with two 5A fuses. A 3.15A fuse protects the low voltage command devices. The accessories' total wattage (24V) must not exceed 20W.

Safety:

PHOTOCELLS CAN BE CONNECTED TO OBTAIN:

Re-Opening: Re-opening during closure (2-C1), if the photocells identify an obstacle while the gate is closing, they will reverse the direction of movement until the gate is completely open;

Total stop (1-2), shutdown of gate movement without automatic closing; a pushbutton or radio remote control must be actuated to resume movement.

Accessories which can be Connected to this Unit:

Flashing signal light when gate is in motion 25W max. (E1-W)

Electric lock (11-ES)

Radiofrequency "AF" board

Other functions available

Automatic closing The automatic closing timer is automatically activated at the end of the opening cycle. The preset, adjustable automatic closing time is automatically interrupted by the activation of any safety system, and is deactivated after a STOP command or in case of power failure.

"Operator present" function Gate operators only when the pushbutton is held down (the radio remote control system is deactivated);

Adjustments

Trimmer TL Adjustment of operating time;

Trimmer TCA Adjustment of automatic closing

Caution! Disconnect the unit from the main power lines before carrying out any operation inside the unit.

Other functions available:

Automatic closing: The automatic closing timer is automatically activated at the end of the opening cycle. The pre-set, adjustable automatic closing time is automatically interrupted by the activation of any safety system, and is deactivated after a STOP command or in case of power failure.

"Operator present" function:

Gate operates only when the pushbutton is held down (the radio control system is deactivated)

Fig 26

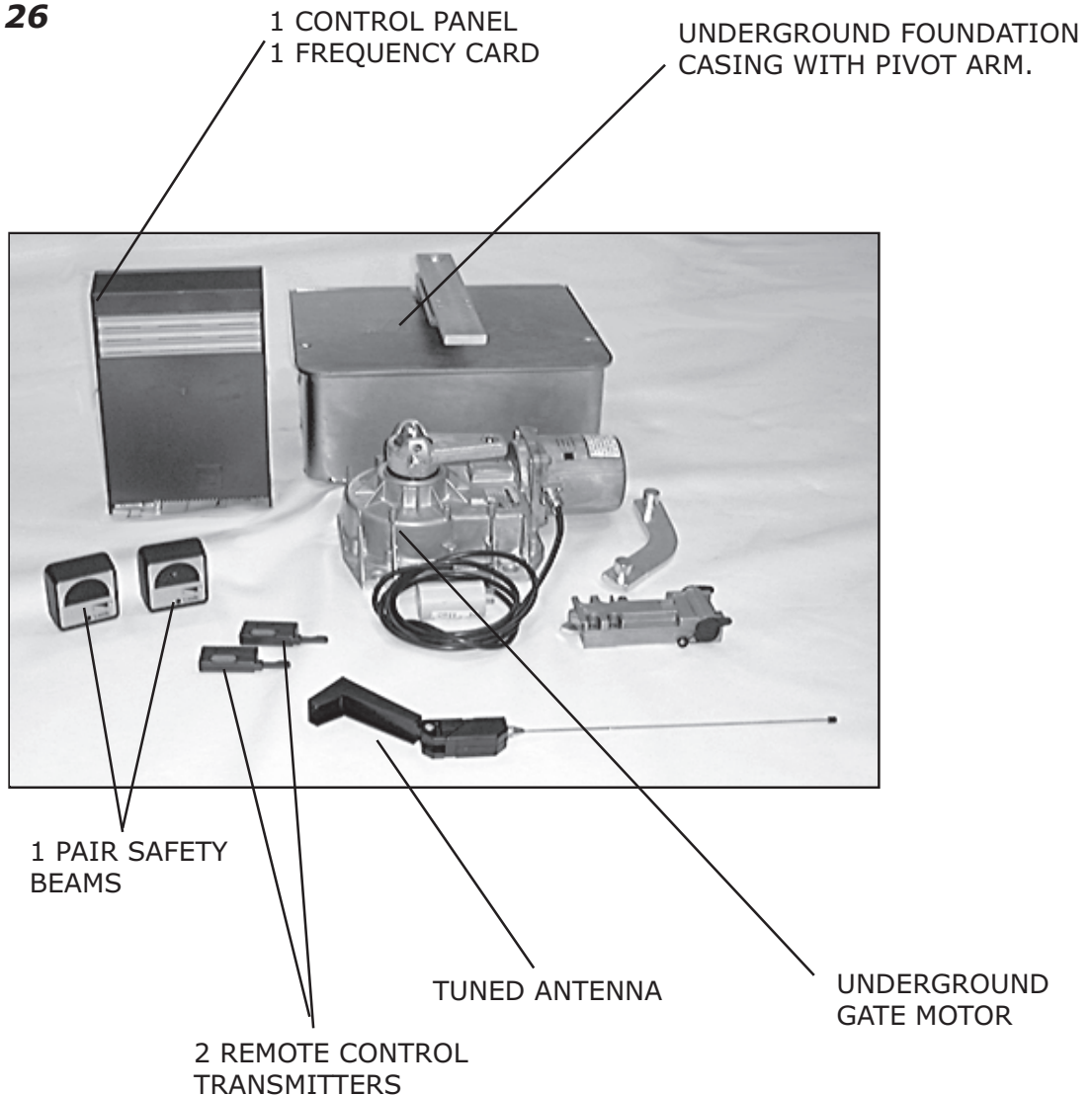

5.6 - ZA5 Wiring Diagram

Terminals 1 and 2, 2 and C1 are normally closed circuits and if they are not used they must be linked

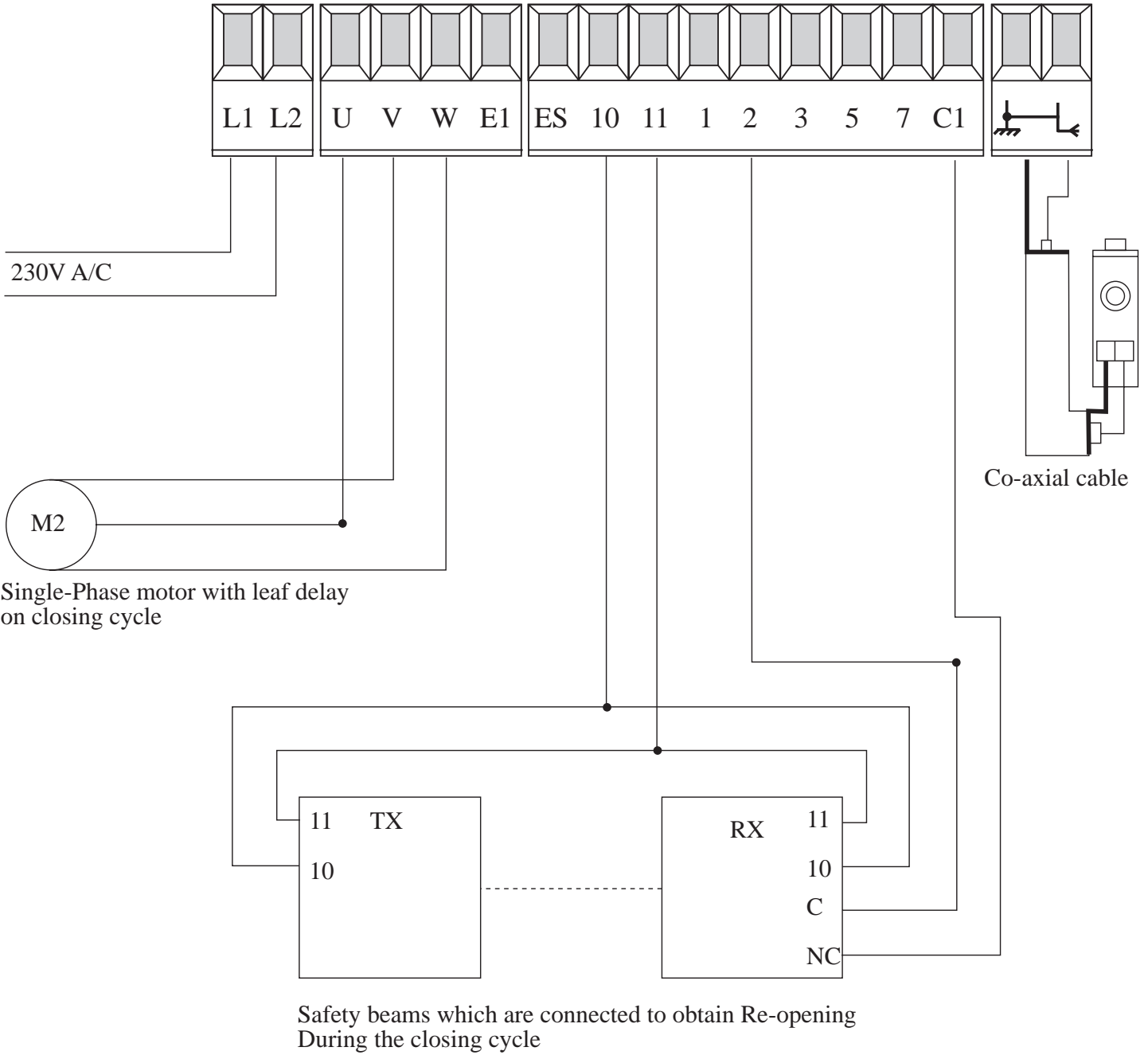

5.7 - Control Panel Adjustments

Trimmer T.L. - Adjustment of operating time from a minimum of 0 seconds to a maximum of 120 seconds N.B. it is advised to let the motors run on for between 6 and 8 seconds after the last gate has fully close.

Trimmer T.C.A - Adjustment of automatic closing time from a minimum of 1 to a maximum of 120 seconds.

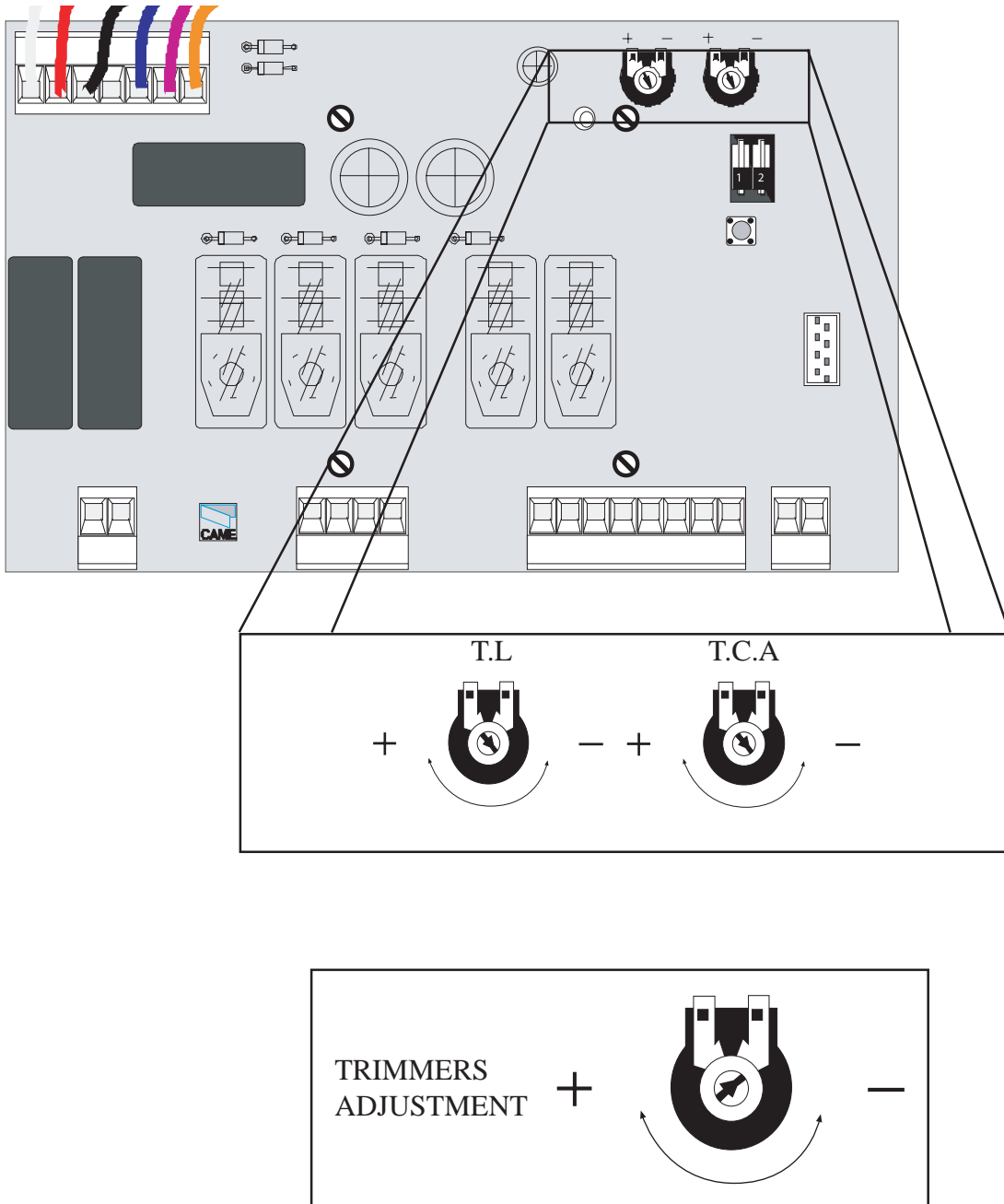
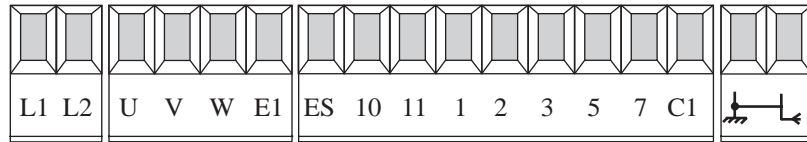

Fig 27

5.8 - Electrical Connections



L1 ————○
L2 ————○ *230V (a.c.) power input*

U ————○
W ————○
V ————○ *230V (a.c.) single-phase motor max. 600W*

W ————○
E1 ————○ *230V (a.c.) output in motion
(e.g. flashing light - max. 25W)*

11 ————○
ES ————○ *(12V - 15W max.) connection for electrically-actuated lock*

10 ————○
11 ————○ *24V (a.c.) Powering accessories (max 20W)*

10 ————○
5 ————○ *(24V-3W max.) "gate-opened" signal lamp*

1 ————○
2 ————○ *Pushbutton stop (N.C.)*

2 ————○
3 ————○ *Open button (N.O.)*

2 ————○
7 ————○ *Contact radio and/or button for control*

2 ————○
C1 ————○ *Contact (N.C.) for re-opening during the closing*

———○
———○ *Antenna connection*

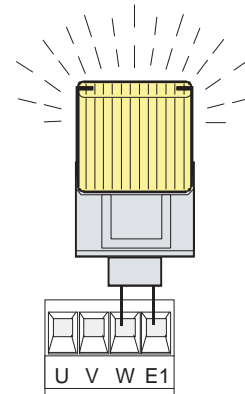

5.10 - Re-Handing the Frog Motors

Fig 28

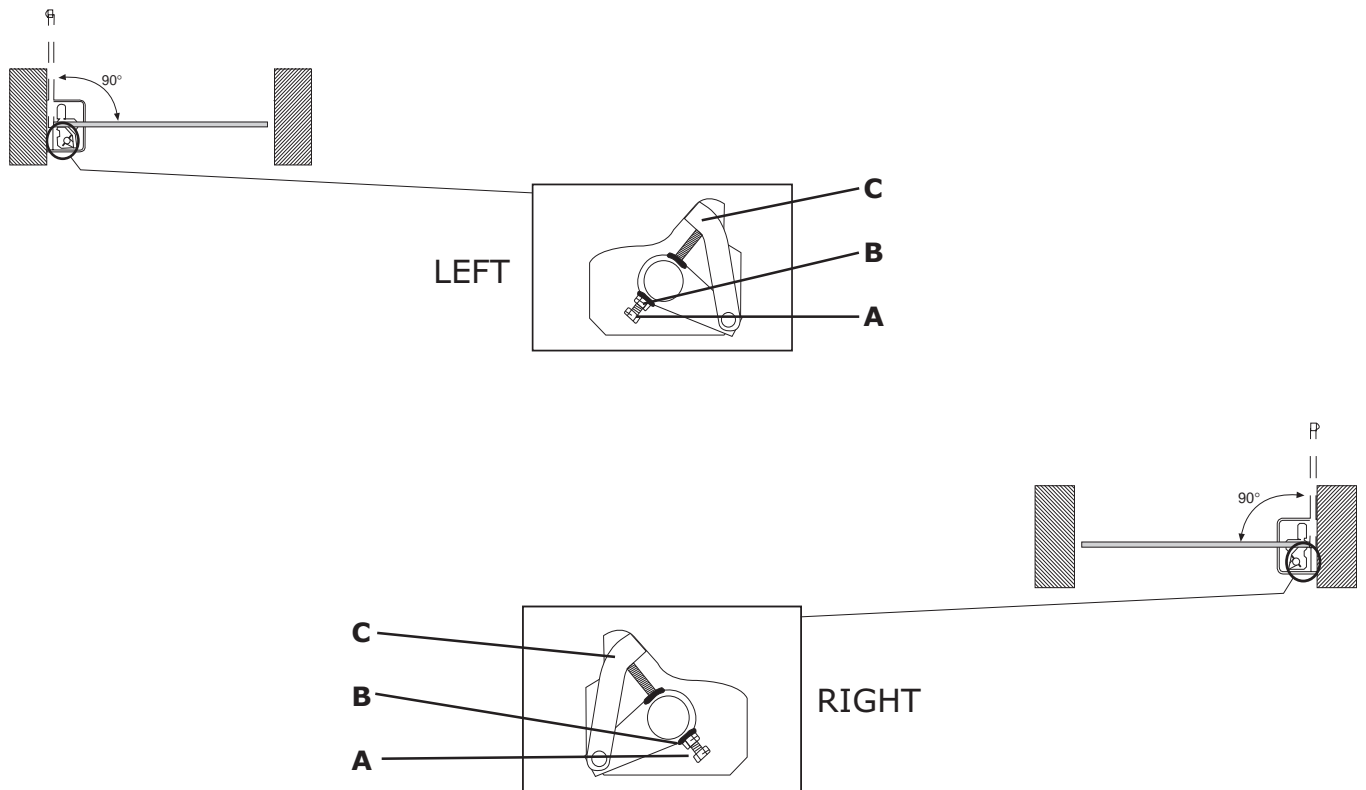

ON RECEIPT YOUR FROG MOTOR WILL HAVE BEEN SETUP FOR YOU AS A PAIR I.E LEFT HAND AND RIGHT HAND BUT SHOULD YOU NEED TO RE-HAND THESE MOTORS THE FOLLOWING INSTRUCTIONS WILL SHOW YOU HOW.

SCREW THE M10 X 100MM BOLT (A) AND THE M10 NUT (B) INTO THE MOTOR TRANSMISSION ARM AS SHOWN IN FIGURE ABOVE. FOR R/H MOTOR INSTALLATION AND FOR L/H MOTOR INSTALLATION SEE FIGURE ABOVE.

ENSURE THAT THE MOTOR IS CORRECTLY FASTENED INTO THE CASING WITH THE NUTS AND WASHERS PROVIDED. INSERT THE LIMIT ARM (C) BETWEEN THE MOTOR TRANSMISSION ARM AND THE FROG SHOE. GIVE THE GATE A COMMAND TO OPEN, WHEN THE GATE COMES TO THE OPEN POSITION AND THEN ADJUST THE SCREW (A).

CLOSE THE GATES SO THAT SCREW (A) MEETS THE LINK ARM. THEN OPEN THE GATE AND ADJUST (A) ACCORDINGLY. DURING ADJUSTMENT ALLOW THE GATE TO PUT ADEQUATE PRESSURE ONTO THE CENTRE STOP BUT ALLOWING THE GATE TO BE RE-LOCKED ONTO THE SHOE AFTER MANUALLY RELEASING THE GATE.

WHEN ADJUSTMENT IS FINISHED FASTEN NUT (B).

NOTES

NOTES

6. CONTACT INFORMATION

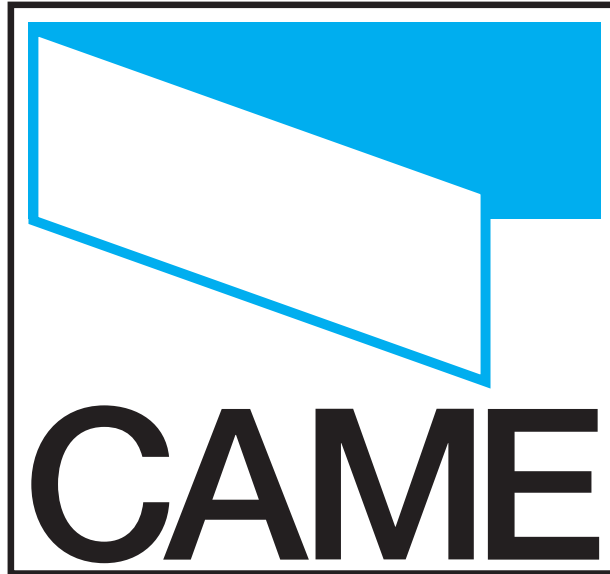

CAME UNITED KINGDOM LTD

UNIT 3

ORCHARD PARK INDUSTRIAL ESTATE
TOWN STREET, SANDIACRE, NOTTINGHAM NG10 5BP

TEL: **0115 921 0430**

FAX: **0115 921 0431**

INTERNET : www.cameuk.com

E-MAIL: enquiries@cameuk.com

THIS INSTALLATION WAS COMPLETED BY:

.....
NAME.....

ADDRESS.....

.....

.....

.....

TEL..... MOBILE.....

DATE OF INSTALLATION.....